

### General Description

This demonstration board utilizes AL8853 to build a cost effective solution for boost LED driver.

AL8853 is a LED driver controller designed for boost converters in a constant frequency mode. It implements a peak current mode control scheme and an internal trans-conductance amplifier to accurately control the output current over a wide input and load conditions.

This user guide contains rich information for the users. A bill of materials is included that describes the parts used on this board. A schematic and PCB layout is also included along with measured system performance characteristics and test waveforms. These materials can be used as a reference design for your products to improve your product's time to market.

### Key Features

1. Wide Input Voltage Range: 20V to 36V
2. Constant Current Mode PWM Controller
3. PWM to Analog Dimming Mode
4. Audio Noise Free
5. Built-in Comprehensive Protections
  - a) Under Voltage Lock Out (UVLO)
  - b) Over Voltage Protection(OVP)
  - c) Over Current Protection(OCP)
  - d) Over Temperature Protection (OTP)
  - e) LED Open Protection
  - f) Output Short Protection
  - g) Diode & Inductor Short Protection
  - h) LED Cathode Short to GND Protection
6. Low system BOM cost

### Applications

- LCD TV
- LCD Monitor
- Flat Panel Display

### Specifications

Parameter	Value
Input Voltage	20V ~ 36V
Output Power	48W
Output Current	800mA
Output Voltage	60V
Efficiency	>90 %
Dimension	70mm*50mm
RoHS Compliance	Yes

### Evaluation Board



Figure 1: Top View



Figure 2: Bottom View

### Connection Instructions:

DC Positive Input: Red Test Point (VIN)  
 DC Negative Input: Black Test Point (GND)  
 PWM Signal Input: P1 (PWM)  
 GND Signal Input: P1 (GND)  
 Positive Output: Red Test Point (LEDA)  
 Negative Output: Black Test Point (LEDK)

### Board Layout

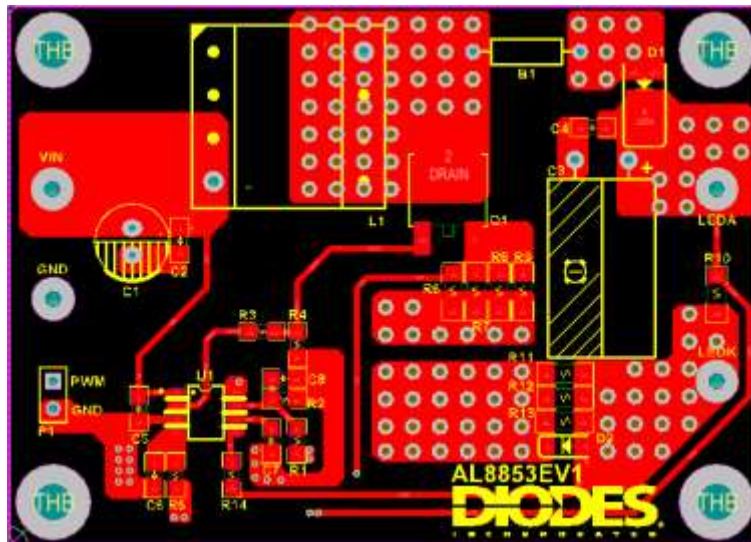

Figure 3: PCB Layout Top View

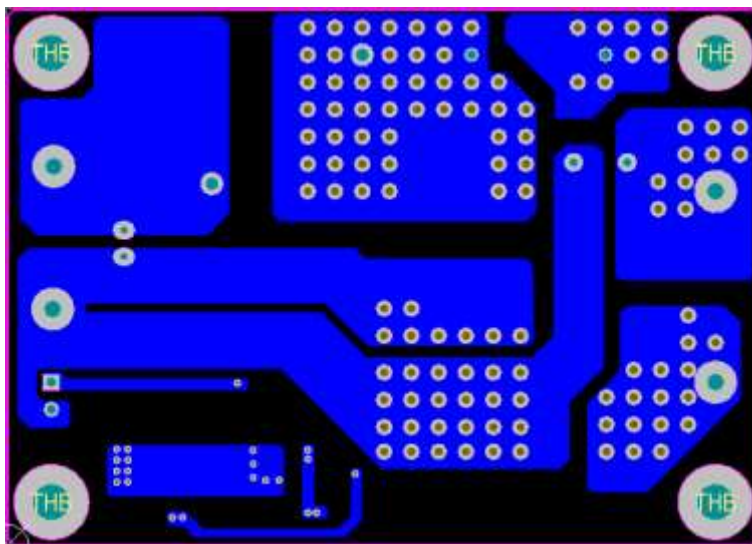

Figure 4: PCB Layout Bottom View

### Quick Start Guide

1. Ensure that the power supply and the PWM signal are switched OFF or disconnected.
2. Connect the LED power supply to the test point “VIN” and “GND”.
3. Connect the LED PWM signal to the test point “PWM” and “GND”.
4. Connect the LED string anode to the test point “LEDA”.
5. Connect the LED string cathode to the test point “LEDK”.
6. Set the PWM signal and turn on the LED power supply. The LED string will light on and output the preset current.

### Schematic

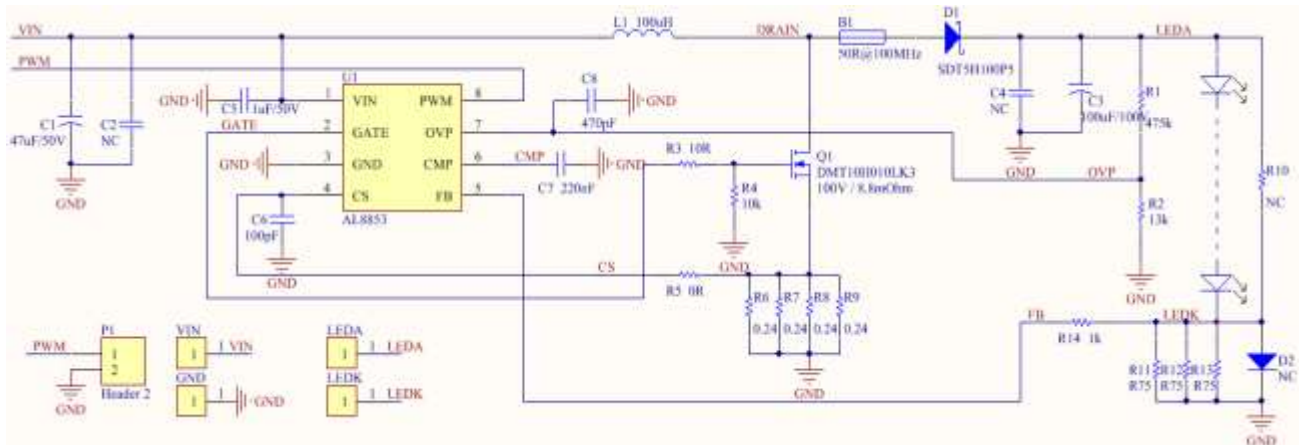

Figure 5: Schematic Circuit

### Bill of Material

Item	Quantity	Package	Description
B1	1	DIP	Ferrite Bead, 50Ω@100MHz
C1	1	DIP	Electrolytic Capacitor, 47uF, 50V, 6.3*11
C3	1	DIP	Electrolytic Capacitor, 100uF, 100V, 10*16
C5	1	0805	Ceramic Capacitor, 1uF, 50V, X7R, ±10%
C6	1	0805	Ceramic Capacitor, 100pF, 16V, X7R, ±10%
C7	1	0805	Ceramic Capacitor, 220nF, 16V, X7R, ±10%
C8	1	0805	Ceramic Capacitor, 470pF, 16V, X7R, ±10%
D1	1	PowerDI5	Schottky Diode, SDT5H100P5, 100V,1A
L1	1	EE1610	Inductor, 100uH, EE1610, 36Ts
Q1	1	TO252	MOSFET, DMT10H010LK3, N Channel, 100V, 8.8mΩ
R1	1	0805	SMD Film Resistor, 475kΩ, ±1%
R2	1	0805	SMD Film Resistor, 13kΩ, ±1%
R3	1	0805	SMD Film Resistor, 10Ω, ±1%
R4	1	0805	SMD Film Resistor, 10kΩ, ±1%
R5	1	0805	SMD Film Resistor, 0Ω, ±1%
R6, R7, R8, R9	4	1206	SMD Film Resistor, 0.24Ω, ±1%
R11, R12, R13	3	1206	SMD Film Resistor, 0.75Ω, ±1%
U1	1	SO-8	IC, AL8853

### System Performance

The AL8853 evaluation board has excellent system performance. With very low BOM cost, the system can achieve high efficiency and good dimming linearity. To enhance reliability, AL8853 also integrates comprehensive protections.

### System Efficiency

Figure 6 shows the efficiency curve. The efficiency is measured with 32V DC input and 20\*LED as load. The efficiency is 95% with 100% duty.

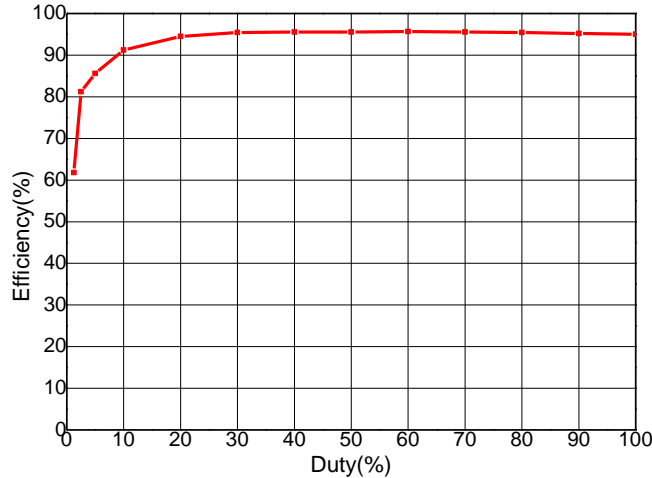

Figure 6: Efficiency vs PWM Duty

### Dimming Performance

AL8853 can support PWM dimming with frequency ranging from 5 kHz to 50 kHz. Figure 7 shows the dimming curve with measured data. AL8853 dimming linearity is quite good with PWM duty from 1% to 100%.

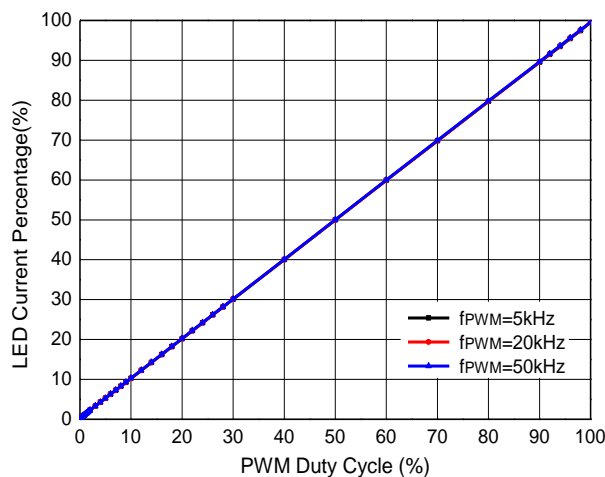

Figure 7: LED Current vs PWM Duty

### LED Open Protection

AL8853 monitors the output voltage through the OVP pin. If the LED string is open, the output voltage will exceed the preset level and the converter will be shut down.

Figure 8 illustrates the LED open protection procedure. In the waveform, channel 1 (yellow) is the GATE signal, channel 2 (red) is the COMP signal, channel 3 (blue) is the OVP pin signal, and channel 4 (green) the LED current. From the waveforms, when  $V_{OVP}$  reaches 2.0V, AL8853 enters LED open protection and the converter shuts down; once the  $V_{OVP}$  drops by the hysteresis value (100mV), the converter continues to switch.

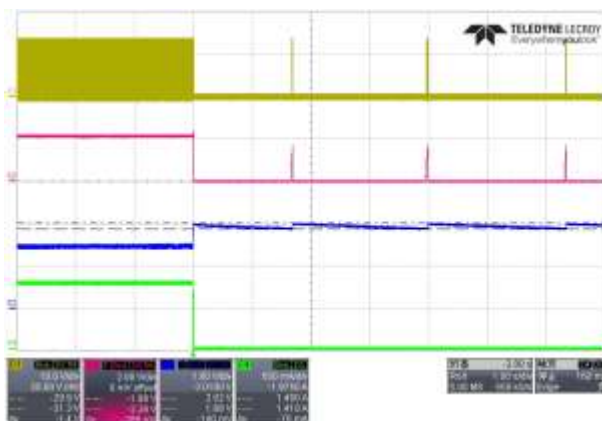

Figure 8: LED Open Protection with 100% Duty

### LED Cathode Short to GND Protection

To prevent LED cathode short to ground, AL8853 monitors the COMP pin voltage. If  $V_{COMP}$  is continuously greater than 3.2V for 37ms, the converter will be shut down.

Figure 9 depicts the LED cathode short to ground protection procedure. In the waveforms, channel 1 (yellow) is the GATE signal, channel 2 (red) is the COMP signal, channel 3 (blue) is the CS signal, and channel 4 (green) the FB signal. From the waveforms, when LED cathode is short to GND, FB drops to  $\sim 0V$  and  $V_{COMP}$  rises. When  $V_{COMP}$  reaches 3.2V and lasts for  $\sim 37$  ms, AL8853 enters protection and latches the system.

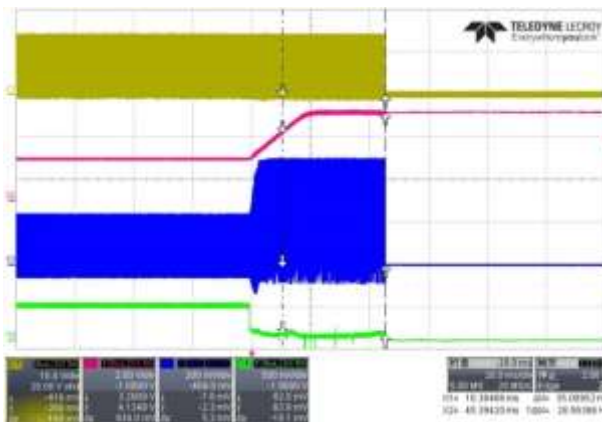
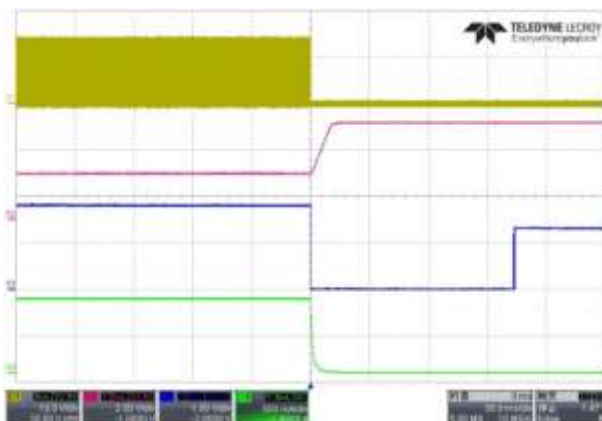

Figure 9: LED Cathode Short to GND Protection with 100% Duty

### V<sub>OUT</sub> Short Protection

AL8853 monitors the OVP pin voltage. If V<sub>OUT</sub> is short, VOVP will drop, and if VOVP drops below 0.25V, the converter will be shut down.

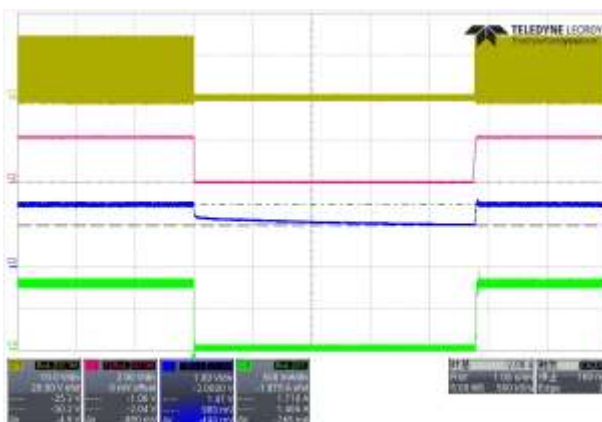

**Figure 10: V<sub>OUT</sub> Short to GND Protection with 100% Duty**

Figure 10 shows the V<sub>OUT</sub> short to ground protection procedure. In the waveforms, channel 1 (yellow) is the GATE signal, channel 2 (red) is the COMP signal, channel 3 (blue) is the OVP signal, and channel 4 (green) the LED current. From the waveforms, when V<sub>OUT</sub> is short to GND, OVP drops to ~0V, below 0.25V, and then AL8853 enters protection and latches the system.

### Over Temperature Protection

When the junction temperature exceeds 160°C, AL8853 enters protection and the converter shuts down.



**Figure 11: Over Temperature Protection with 100% Duty**

Figure 11 illustrates the over temperature protection procedure. In the waveforms, channel 1 (yellow) is the GATE signal, channel 2 (red) is the COMP signal, channel 3 (blue) is the OVP signal, and channel 4 (green) the LED current. From the waveforms, when the IC junction temperature exceeds the threshold temperature 160°C, AL8853 shuts down; once IC junction temperature drops by 30°C, AL8853 automatically restarts.

### LED Anode Short to GND

If the LED anode short to GND protection is required, the diode D2 is in need to prevent the FB pin from damaging. A diode should be placed to D2 whose peak repetitive reverse voltage should be no less than 100V and output current should be no less than 2A.

### Constant Voltage Mode

AL8853EV1 can also be configured to work in constant voltage mode. The PWM pin should be connected to a constant voltage (3.3V / 5V). For the 60V constant voltage output application, the below modifications should be implemented.

1. A 750k $\Omega$ , 1% precision, 0805 package resistor should be placed on R10.
2. R11, R12, R13 should be removed, and R11 be replaced by a 2.49k $\Omega$ , 1% precision, 0805 package resistor.
3. C7 should be replaced by a 10nF 0805 capacitor.

The constant output voltage can be measured between LEDA and GND.

### System Efficiency

Figure 12 shows the efficiency curve. The efficiency is measured with different load current. The efficiency of AL8853EV1 constant voltage mode can reach 94% with 24V DC input and 95% with 32V DC input.

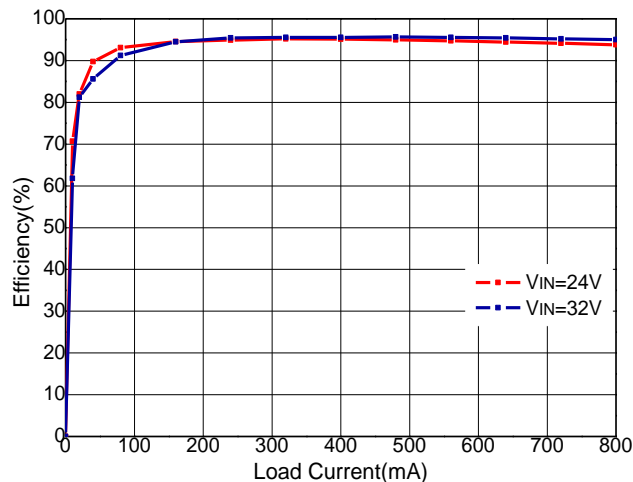
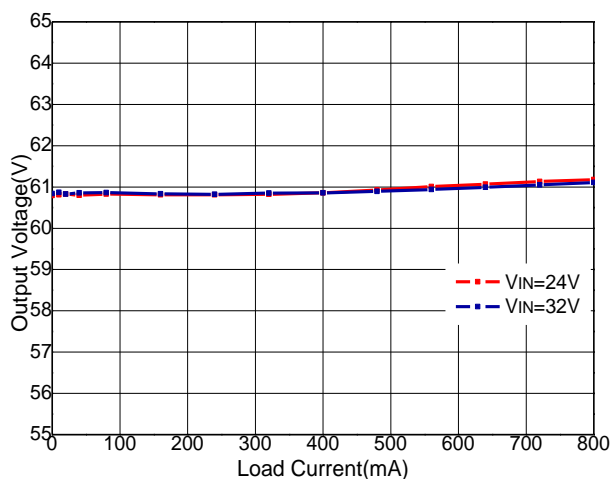

Figure 12: Efficiency vs Load Current

### Load Regulation

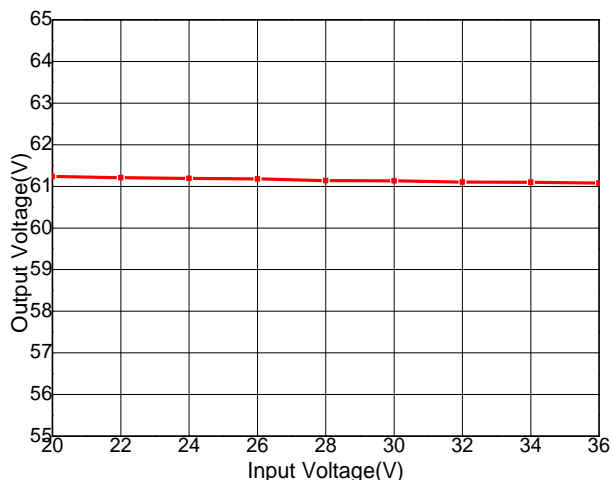

**Figure 13: Output Voltage vs Load Current**

Figure 13 shows the output voltage with different load current. The measured output voltage with 0~800mA load ranges 60.8V to 61.2V. The load regulation rate is 0.6%.

### Line Regulation

Figure 14 shows the output voltage with different input voltage. With 20V ~ 36V DC input, the output voltage at 800mA load ranges from 61.24V to 61.10V. The line regulation rate is 0.2%.



**Figure 14: Output Voltage vs Input Voltage**

### Load Transient

The load transient waveform in Figure 15 is measured with the load current switching from 0mA to 800mA, rising slew rate 1A/μs, and from 800mA to 0mA, falling slew rate 1A/μs. When loading, the output voltage drops to 52.75V for a very short time. When unloading, the maximum output voltage is 65.10V.



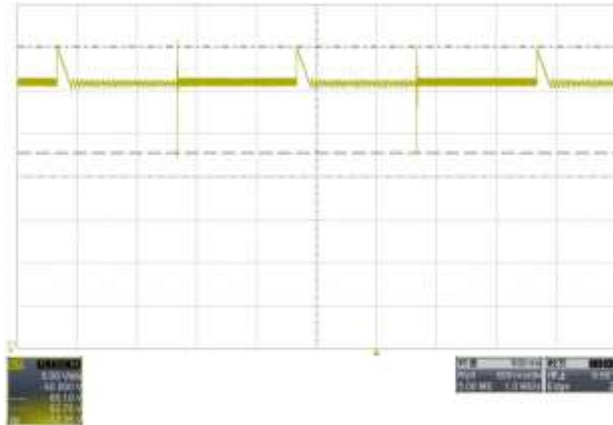

Figure 15: Load Transient with 32V Input

### IMPORTANT NOTICE

DIODES INCORPORATED MAKES NO WARRANTY OF ANY KIND, EXPRESS OR IMPLIED, WITH REGARDS TO THIS DOCUMENT, INCLUDING, BUT NOT LIMITED TO, THE IMPLIED WARRANTIES OF MERCHANTABILITY AND FITNESS FOR A PARTICULAR PURPOSE (AND THEIR EQUIVALENTS UNDER THE LAWS OF ANY JURISDICTION).

Diodes Incorporated and its subsidiaries reserve the right to make modifications, enhancements, improvements, corrections or other changes without further notice to this document and any product described herein. Diodes Incorporated does not assume any liability arising out of the application or use of this document or any product described herein; neither does Diodes Incorporated convey any license under its patent or trademark rights, nor the rights of others. Any Customer or user of this document or products described herein in such applications shall assume all risks of such use and will agree to hold Diodes Incorporated and all the companies whose products are represented on Diodes Incorporated website, harmless against all damages.

Diodes Incorporated does not warrant or accept any liability whatsoever in respect of any products purchased through unauthorized sales channel.

Should Customers purchase or use Diodes Incorporated products for any unintended or unauthorized application, Customers shall indemnify and hold Diodes Incorporated and its representatives harmless against all claims, damages, expenses, and attorney fees arising out of, directly or indirectly, any claim of personal injury or death associated with such unintended or unauthorized application.

Products described herein may be covered by one or more United States, international or foreign patents pending. Product names and markings noted herein may also be covered by one or more United States, international or foreign trademarks.

### LIFE SUPPORT

Diodes Incorporated products are specifically not authorized for use as critical components in life support devices or systems without the express written approval of the Chief Executive Officer of Diodes Incorporated. As used herein:

- A. Life support devices or systems are devices or systems which:
  - 1. are intended to implant into the body, or
  - 2. support or sustain life and whose failure to perform when properly used in accordance with instructions for use provided in the labeling can be reasonably expected to result in significant injury to the user.
- B. A critical component is any component in a life support device or system whose failure to perform can be reasonably expected to cause the failure of the life support device or to affect its safety or effectiveness.

Customers represent that they have all necessary expertise in the safety and regulatory ramifications of their life support devices or systems, and acknowledge and agree that they are solely responsible for all legal, regulatory and safety-related requirements concerning their products and any use of Diodes Incorporated products in such safety-critical, life support devices or systems, notwithstanding any devices- or systems-related information or support that may be provided by Diodes Incorporated. Further, Customers must fully indemnify Diodes Incorporated and its representatives against any damages arising out of the use of Diodes Incorporated products in such safety-critical, life support devices or systems.

Copyright © 2021, Diodes Incorporated

[www.diodes.com](http://www.diodes.com)